



BORN ELECTRIC  
LITHIUM



#### Snow tank volume

3 m<sup>3</sup> / compacted 3.6 m<sup>3</sup>  
(106 ft<sup>3</sup> / compacted 130.7 ft<sup>3</sup>)



#### Water tank volume

1,000 l (264 gal)  
1,350 l (356.6 gal)  
1,750 l (462 gal)

+ Snow tank-water tank connection  
>2,000 l (528 gal)



#### Blade width

2,100 mm (82 5/8 in)  
or 2,300 mm (90 1/2 in)



#### Fields of operations

Pro / Heavy duty



# STADIUM EFFICIENCY

Powerful drive with electric engines together with a large snow and water tank capacity: The WM Shira has been purpose-designed for resurfacing stadiums. It boasts an immensely impressive price/quality ratio and, on request, can be fitted with countless extras. WM Shira. The perfect partner for professional resurfacing of ice surfaces of up to 1,800 m<sup>2</sup> (19,368 ft<sup>2</sup>).

*„The WM Shira has everything we need to resurface the ice in our stadium to perfection. We are absolutely delighted with it!“*



**Louis Eberle**

Ice expert at the Ice Sports Centre  
Oberstdorf / Germany



HIGHLIGHT

## ***EVERYTHING UNDER CONTROL IN THE DRIVER'S CAB***

The WM Shira is a guarantee of outstanding comfort for the driver and boasts a full, unobstructed view whether you're driving cabin-free or with all-round glazing. Three steps provide easy entry to the vehicle. All important information is clearly visible at a glance on the high-definition colour display, and all the main functions are keyboard-controlled. At a simple press of a button the automatic mode begins all work operations in a pre-defined order.





## ***INTEGRATED EDGER FOR END-TO-END RINK PERFECTION***

The edger is fixed to the body of the WM Shira, guaranteeing you outstanding stability and performance. It can be operated easily and safely from the driver's seat. The innovative horizontal spring-loaded system with guide wheel ensures that the edger follows the contours of the rink to perfection, and planes the ice evenly, rapidly and cleanly. Edging and subsequent cleaning of the ice surface with the swivel brushes can be carried out in one simple step. The edgers are positioned between the axels and in front of the brush, to ensure an unrestricted overview of the vehicle. When not in use, the edgers are stored between the wheels, and do not affect operation in any way.

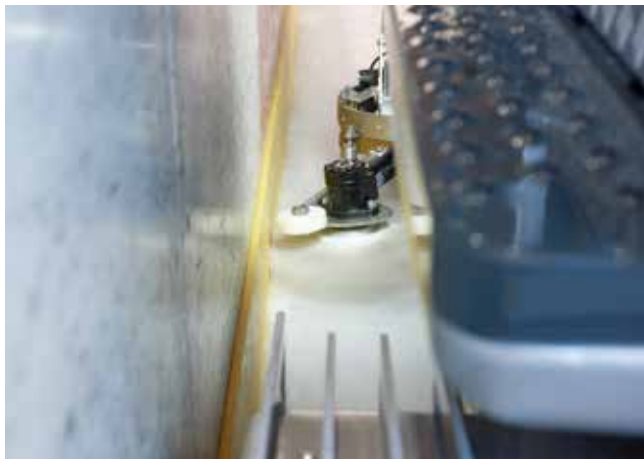









## HIGHLIGHT

# ***FUN ALL THE WAY: THE PASSENGER'S SEAT***

No other ice resurfer has it – anybody who wants to see a specialist at work close-up can sit comfortably by the operator's side. The passenger's seat is also a wonderful marketing tool, as it gives the spectator the chance to see the rink from a new perspective during the break. A competition or raffle prize never fails to add an extra thrill to the game!



## HIGHLIGHT

# ***NEED MORE THAN 2,000 LITRES (528 GAL) OF WATER? NO PROBLEM!***

When you're building up ice depth or using the water sprayer, more water is a must. The WM Shira has it all taken care of! The water and snow tanks can easily be connected into one water tank with a total volume of around 2,000 litres of water. No more standing in cold water and tiresome tugging on hoses: All operations can be carried out from the comfort of the driver's cab – there's more than enough water to do the job.

Example: 1,350-litre (356.6 gal) water tank & 1,000-litre (264 gal) snow tank = 2,350 litres (620.6 gal) of water





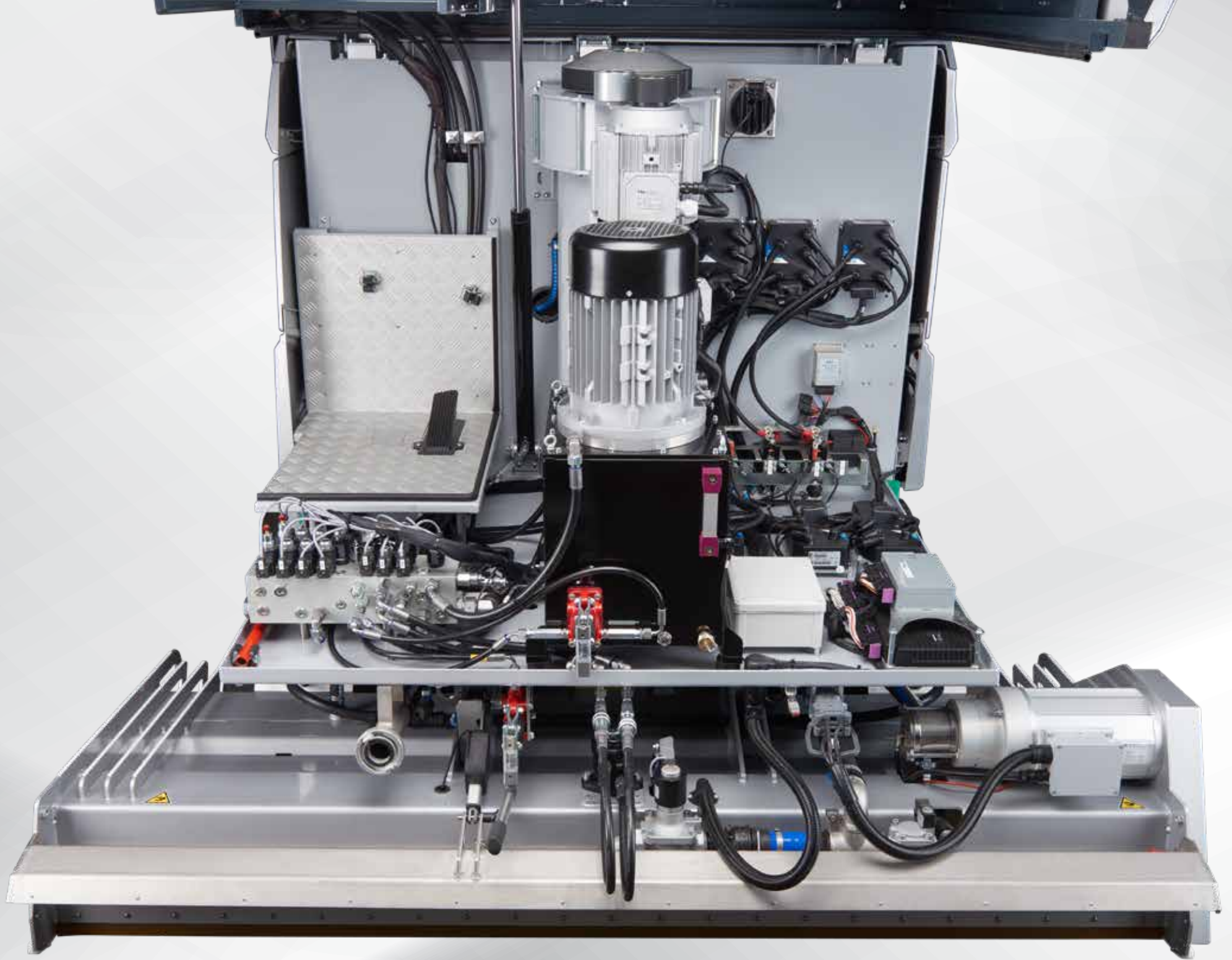

## MAINTENANCE

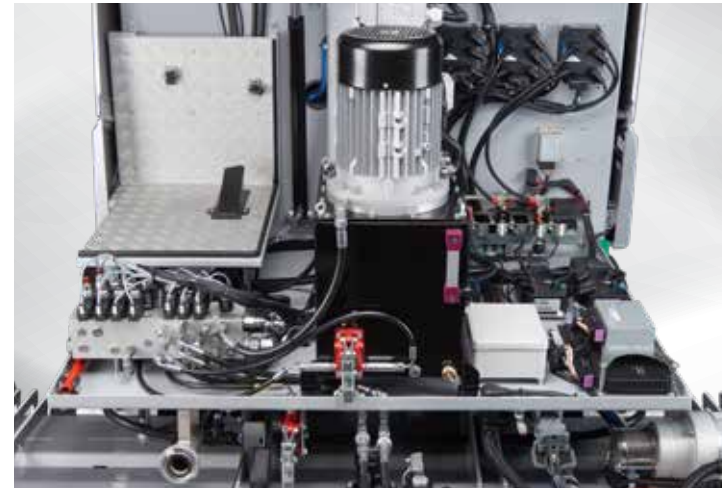

The entire engine technology is easily accessible just by lifting the cab. This means that mechanics can carry out their work quickly and cleanly, which in turn saves on time and service costs. Our team also use remote monitoring to keep an eye on your vehicle monitor and rectify any faults which may occur.

- COST EFFICIENT** 📌
- FREE AND EASY ACCESS** 📌
- SKILLED REMOTE MAINTENANCE** 📌

## ELECTRIC / LITHIUM



## FACTS & FIGURES

<b>Motor</b>	5 asynchronous motors
<b>Power rating</b>	29 kW
<b>Water tank</b>	1,000 l (264 gal) optional 1,350 l (356.6 gal) / 1,750 l (462 gal)
<b>Snow tank</b>	3 m <sup>3</sup> (106 ft <sup>3</sup> ) – compacted 3.6 m <sup>3</sup> (130.7 ft <sup>3</sup> )
<b>Transmission</b>	Continuously adjustable electric four-wheel drive
<b>Hydraulic oil tank</b>	50 l (13.2 gal)
<b>Speed</b>	0 - 13 km/h (0 - 8 mph)
<b>Tyres</b>	225 / 75 / R16 C - 6 rows of spikes
<b>Wheel rims</b>	9" x 16"

## INCLUDED IN DELIVERY



2 blades in  
transport sheath



2 towels



2 rubber mats



Tool to adjust and  
change blades



Key for water filter



1 set hexagonal  
socket screws



Bodywork key



Set ABS  
fastening material



Laceration-proof  
safety gloves



Grindstone



Storz coupling C  
with nozzles  
ø 32, ø 40, ø 50



Fuse set



Operating instructions



Online spare  
parts catalogue

## STANDARD EQUIPMENT

PLC control

---

High-resolution 7" touchscreen

---

Button for automatic modus: operations start automatically in a fixed order

---

Function for automatic water filling system with immobilizer (Acquastop valve as optional)

---

Acoustic signal for reverse drive, snow bin cover operation and reverse of the screw conveyors

---

Spring-suspended and height-adjustable driver's seat with armrests

---

Spring suspended passenger seat

---

Easily accessible engine compartment (tiltable) with cap support

---

Maintenance-free asynchronous motors

---

Continuously adjustable electric four-wheel drive

---

Water tank made of PE

---

Coated snow bin

---

Snow bin & water tank connection

---

> 2,000 litres (> 528 gal)

---

Hydraulic negative parking brake

---

Hydraulically driven and swivelling side brush

---

Board guide pulley

---

Side mirror, rear

---

Snow bin headlight, side headlight

---

Flashing warning light

---

System for water dosing in curves

---

Constant grinding pressure planing system

---

2 blades

---

2 towels

---

Scope of delivery set

---



In compliance with Suva-type examination certificate  
Nr. E 7224.e



### Snow tank volume

**3 m<sup>3</sup> / compacted 3.6 m<sup>3</sup>**  
(106 ft<sup>3</sup> / compacted 130.7 ft<sup>3</sup>)



### Water tank volume

**1,000 l (264 gal)**  
**1,350 l (356.6 gal)**  
**1,750 l (462 gal)**



### Blade width

**2,100 mm (82 5/8 in)**  
**or 2,300 mm (90 1/2 in)**



### Fields of operations

**Pro / Heavy duty**

# DIMENSIONS

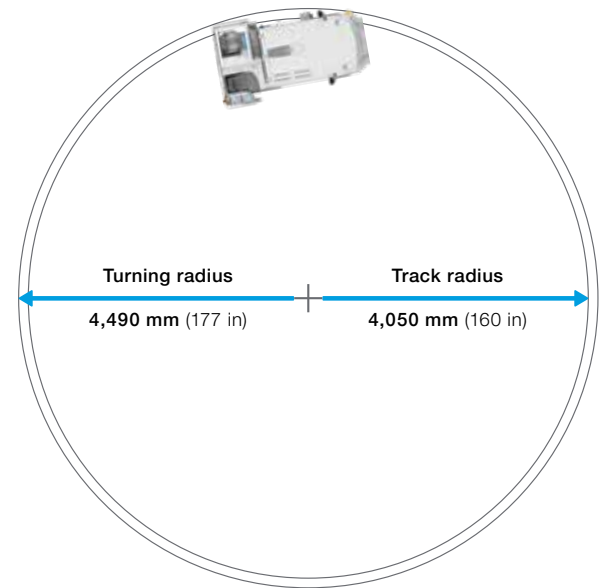
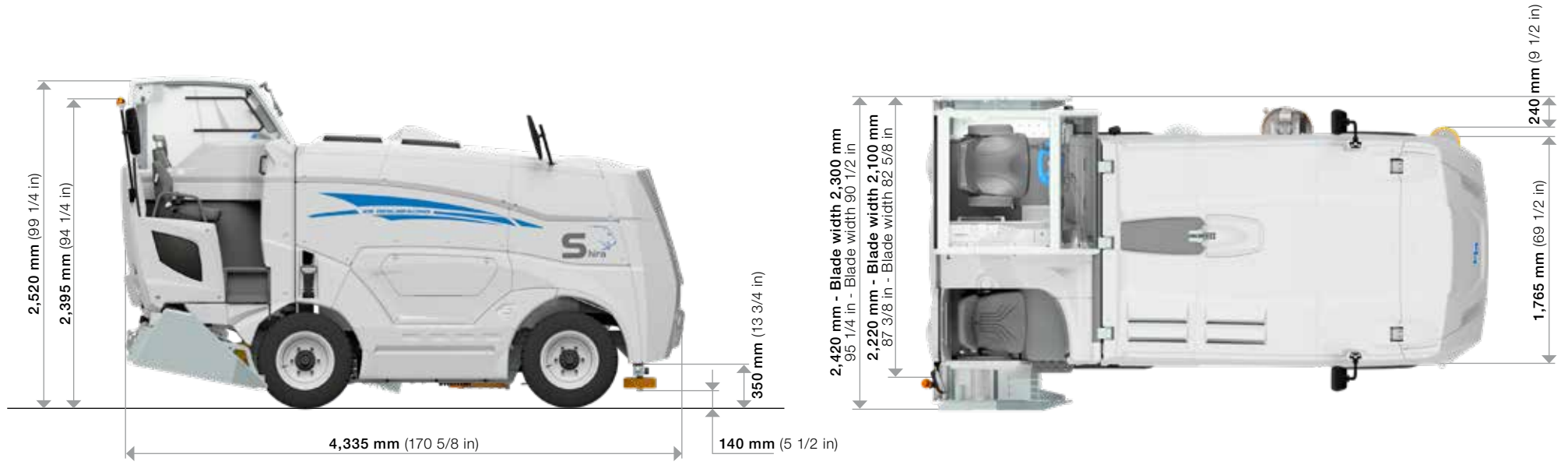



# OPTIONALS

## Water dosing & wash system



Water pump



Ice wash system  
Multijet



Screw conveyor wash  
system vertical



Screw conveyor wash  
system horizontal



Snow bin  
wash system

## Water application



Wheel wash system  
co-steering



Towel support  
standard



Towel lifter  
automatic



ICEplus  
*Water spraying system*



ICEplus Flexi  
*Water spraying system  
with automatic towel lifter*

## Dasher board processing



Water sprayer



Edger  
in galvanised steel,  
electric height adjustment

# OPTIONALS

## Overview & security

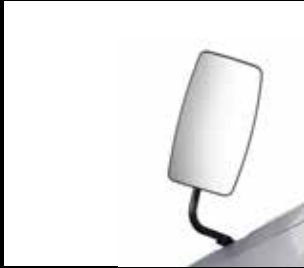

Side mirror  
front left

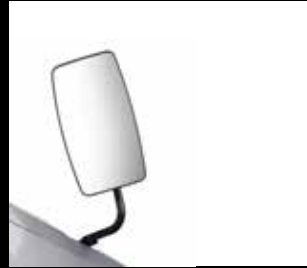

Side mirror  
front right

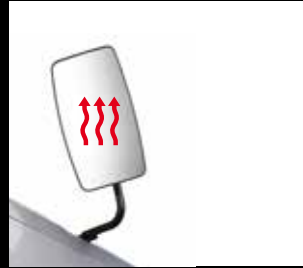

Heated mirrors



Acoustic distance  
warning system front



Front camera

## Comfort



Rear-view camera



Service brakes



Windscreen made of real  
glass with wiper system



Cabin with panoramic  
windows



Cab heating



Driver's seat heating  
*Seat pad*



Radio with  
2x 10 cm speakers



Acquastop valve

## Lighting



Low-beam headlights



High-beam headlights  
with parking lights



Tail lights  
Parking light & brake light



Reversing lights



Turn signal  
front, rear and side



Complete lighting  
system



LED daytime  
running light



RGB underbody  
illumination

## Remote Maintenance



Connect

## Personalization



Painting  
1 color RAL



Painting  
2 color RAL



Wrapping

# OPTIONALS

## Service



Cross-key



Lifting jack  
with bar 10t



Tool set



Assembly tool for  
nozzles ICEplus



Kit diagnostic  
cables



Battery trolley



Battery water  
filling system



Comfort blade change,  
with screws



Sled tilting device



Spare wheel 16"

## Attachments for Bavarian Curling



Access BMU  
Battery-Monitoring-Unit



Groove harrow



# OUR COMMITMENT

## User friendliness

Through the use of top-quality components together with a well-planned design, maintenance work is extremely simple and is reduced to a minimum.



## Quality guarantee

The WM Shira is a product which has been developed, built and assembled in house, from start to finish. Only by doing so can we guarantee top quality and punctual delivery times.



## Detailed operating instructions

You can find all information on operation, maintenance and safety in the operating manual.

## The right replacement part, every time

Order your spare parts easily and conveniently from our online portal: Our series number and digital image system enable you to find the part you need with just one click.



### Service and support

Our well-networked, international team of technicians undergo constant training and will be delighted to help you whenever you require assistance.



### Series production

All WM technics vehicles are series-manufactured. We know exactly which parts have been used in each series run, and can deliver the correct spare parts to you at all times. At the same time, a number of optionals can be retrofitted with minimum effort and maximum precision, even years later.

### Quality consciousness

From the manufacture of individual parts right through to the final quality-control inspection: Every step of the process is carried out and monitored with the utmost of precision. Each and every member of our staff is well-trained in his specialist field, and carries out all tasks conscientiously. This is a great advantage for our customers, who can be sure of receiving a technologically sophisticated product which has been manufactured to the very highest of quality standards.





www.wm-on-ice.com  
Italy

WM ice technics relies on the following distribution partners in North America:



**Autoworq**  
Montreal (Québec)  
Phone 1-866-973-1333  
www.autoworq.com



**LSK Enterprises**  
Virginia Beach (VA)  
Phone 1-757-366-0166  
www.lskenterprises.com



**Outdooricerinks.com**  
Strongsville (OH)  
Phone 1-440-628-7979  
www.outdooricerinks.com



Mobile / Event

Pro / Heavy duty



**Compact**



**evo**