

Compact

电动车型
锂电池
柴油车型



冰面·工艺大师



雪箱

1.8 m³ / 压实 2.25 m³



水箱

600 升



刀片宽度

1,700 mm



应用范围

移动/赛事冰场



elmiVome 24h shopping

BIÈRE
BEER

rothoblaas rothoblaas

KAROS
MORAN

FLA
AUGEN
K

为您活动准备的冠军

无论是体育赛事还是圣诞集市：WM Compact是较小的冰场和大型移动冰场紧凑型专业浇冰车的选择。合身强劲的柴油发动机驱动，非常适合在户外使用，使用交流电动机的电动车型适合要求零排放的室内使用。WM紧凑型浇冰车可以像任何大型专业冰车一样浇冰，为1200平米的冰场保证出色的冰质。



亮点

专业品质浇冰

稳固的WM Compact易于操作，并为驾驶员提供出色的舒适感。凭借其久经考验的清冰系统，碎冰机和集成式边刷，WM Compact保证了完美，专业的浇冰。因此，即使在较小的移动冰场上也可有出色的冰面质量及绝佳的滑冰体验！





浇冰

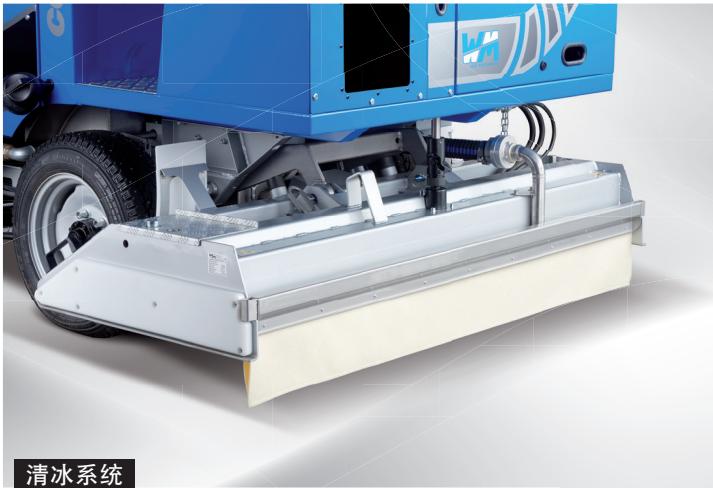

WM Compact可以如大型专业机器一样清冰！
液压驱动型边刷确保边缘完美光滑。有涂层的雪箱很容易清洗。

600 升水 +

出色的清冰性能 +

雪箱清洗容易 +

服务 & 维护

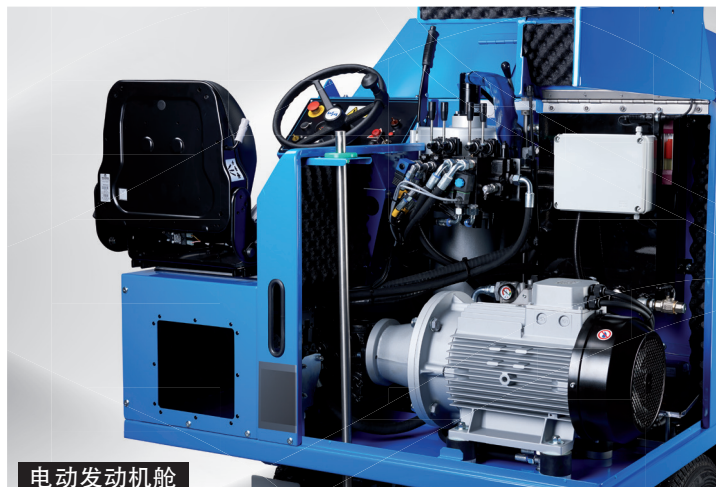
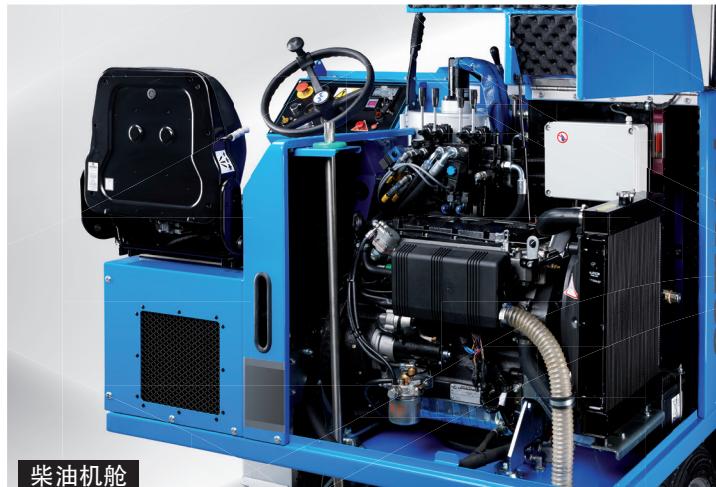

发动机区域易于检修，无需拆卸。维护快速且便宜。
寿命长的Fronius电池充电系统可确保高效和低运营成本。

- 轻松快捷 +
- 低维护成本 +
- 高效节能 +

电动车型 / 锂



随货交付



运输杆上的两把刨刀



2块抹布



2块橡胶垫



6毫米六角套筒
T型扳手



多功能扳手



内六角扳手套装



车身钥匙



防撕裂
安全手套



磨刀石



德式D型快速接头
ø 25



保险丝组



操作手册

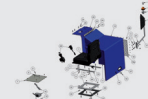

在线备件手册

技术参数

电机	异步电机
功率	15 kW
脉冲控制器	交流CURTIS科蒂斯控制器
空转速度	900 rpm
运行转速	1,900 rpm
驱动系统	连续可调 液压四轮驱动
速度	0 - 12 km/h
雪箱	1.7 m ³ - 压实 2.1 m ³
水箱	600 升 (不锈钢)
轮胎	175 / 70 R 14C 2 排胎钉

标准配置

碎雪机
边刷 (液压驱动)
驻车制动器
侧向导向轮
侧视镜, 后方
侧大灯
轮廓标志灯
倒车、雪箱盖操作警示音
免维护的异步电机
驾驶室的指示灯:
水箱液位, 电池充电状态, 电流消耗, 电机控制器
雪箱涂层
PLC 控制
弹性驾驶座椅
易于接近的发动机舱 (可倾斜发动机盖)
2 块刀片
2 块抹布
配件套装



CE



雪箱

1.7 m³ / 压实 2.1 m³



水箱

600 升



刀片宽度

1,700 mm



应用范围

移动/赛事

柴油车型



随货交付



运输杆上的两把刨刀



2块抹布



2块橡胶垫



6毫米六角套筒
T型扳手



多功能扳手



内六角扳手套装



车身钥匙



防撕裂
安全手套



磨刀石



德式D型快速接头
ø 25



保险丝组



操作手册

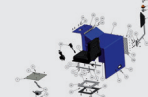

在线备件手册

技术参数

发动机	Kohler KDW 1404, 4 缸 1,372 cm ³
功率	25,60 HP (18,80 kW) - 2,700 rpm
转矩	66,50 Nm - 2,000 rpm
运行转矩	2,600 rpm
油箱	27 升柴油
驱动系统	连续可调 液压四轮驱动
速度	0 - 12 km/h
雪箱	1.8 m ³ - 压实 2.25 m ³
水箱	600 升(不锈钢)
空车重量	1,650 kg
轮胎	175 / 70 R 14C 2排胎钉

标准配置

碎雪机
边刷 (液压驱动)
驻车制动器
围板导向轮
液压油冷却器
侧视镜, 后方
侧大灯
闪烁警示灯
倒车、雪箱盖操作警示音
驾驶室的指示灯: 水箱液位, 油箱液位, 电流消耗, 发动机转速与控制灯
雪箱涂层
PLC 控制
弹性驾驶座椅
易于接近的发动机舱 (可倾斜发动机盖)
2 块刀片
2 块抹布
配件套装



CE



雪箱

1.8 m³ / 压实 2.25 m³



水箱

600 升



刀片宽度

1,700 mm



应用范围

移动/赛事

选配

萃取系统

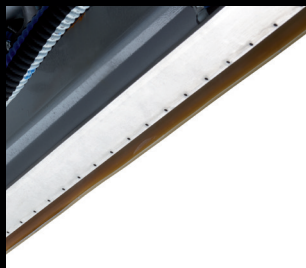

抽吸支架

洗车



竖直卷龙冲洗系统

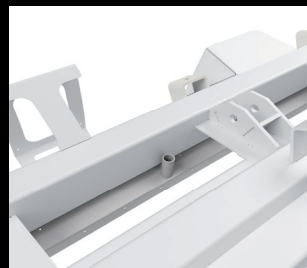

水平绞龙清洗系统

概述和安全



左前方侧镜



右前方侧镜

舒适



司机座位加热垫



止水阀
配时间继电器

照明



前大灯

客户定制



定制颜色车身漆
1 RAL 颜色



框架和刨削单元的油漆
单色RAL



定制车身标识

服务



电池推车



电池水充注系统



14 “备胎



十字扳手



3吨起重千斤顶



工具套装



诊断电缆套件 控制器



诊断电缆套件 BMS



电池监控单元

连接配件

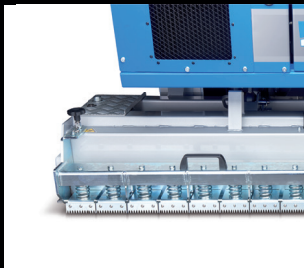

槽耙
冰盘场地

尺寸

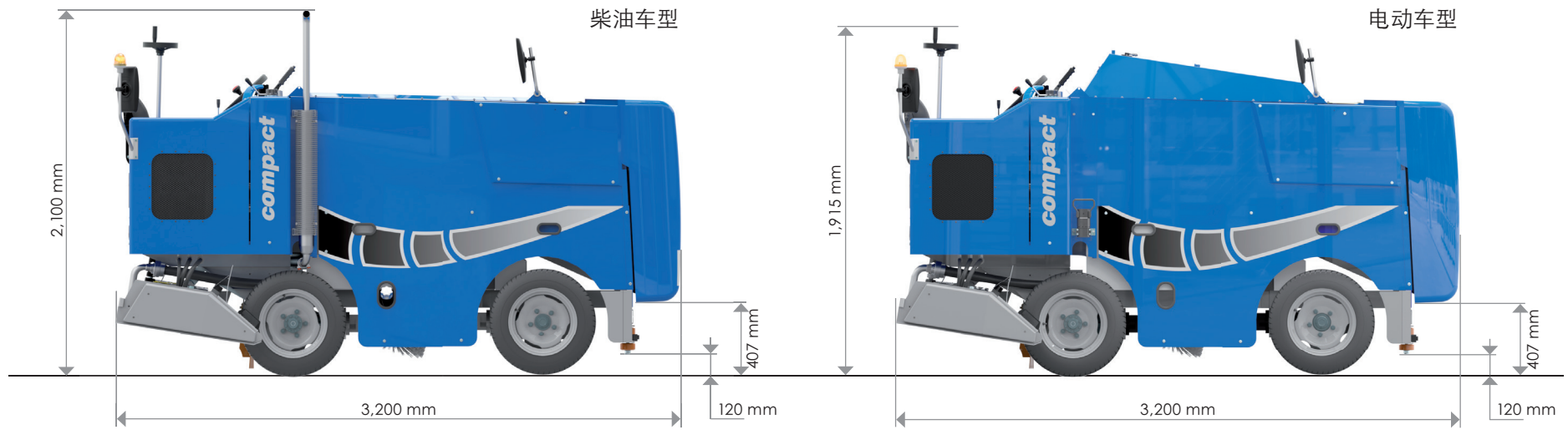



WM COMPACT 柴油车型





我们的承诺

方便用户使用

高质量的部件和精密的设计技术可以简化和最大限度地减少维修操作。



质量保证

WMCompact是一款从头到尾一直在工厂内部开发、制造和组装的产品。只有这样，我们才能保证最高质量和准时交货时间。



详细的操作说明

您可以在操作手册中找到有关操作、维护和安全的的所有信息。

随时选择正确的配件

通过我们的在线商店，您可以轻松快捷的预定任何备件。依托序列号和图片您只需要单击一下就可以找到任何需要的备件。

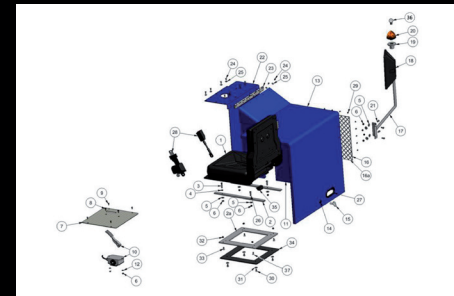

服务与支持

我们所有的国际联网的技术人员队伍都会不断的培训接受，并在需要时提供帮助。



批次生产

WM冰上工艺的所有机器都是批次生产的。我们知道使用了哪些组装部件，并且可以随时根据需要提供正确的替换零件。与此同时，各种选配都可以精确地进行改造，甚至几年之后也能轻易地更换。

质量意识

从单个组件的生产到最终的质量测试，每一步都可以精确跟踪。所有员工都在其专业领域接受过严格的培训，并认真履行职责。其结果是为我们的客户提供的高质量产品，按照最高质量标准进行生产。



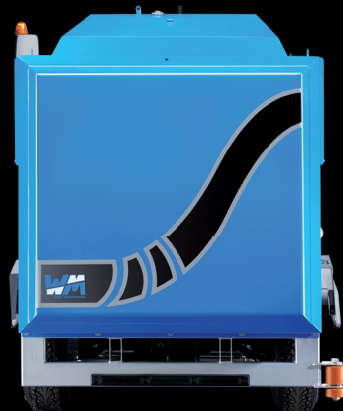

Compact



WM Compact



冰面·工艺大师

WM technics GmbH
Breiener Straße 15
I-39053 Blumau
Tel. +39 0471 353 332
info@wm-technics.com

www.wm-on-ice.com



移动/赛事冰场



专业/大型冰场



Compact



evo